

E 27 CLASS II  IP55

Art.:270

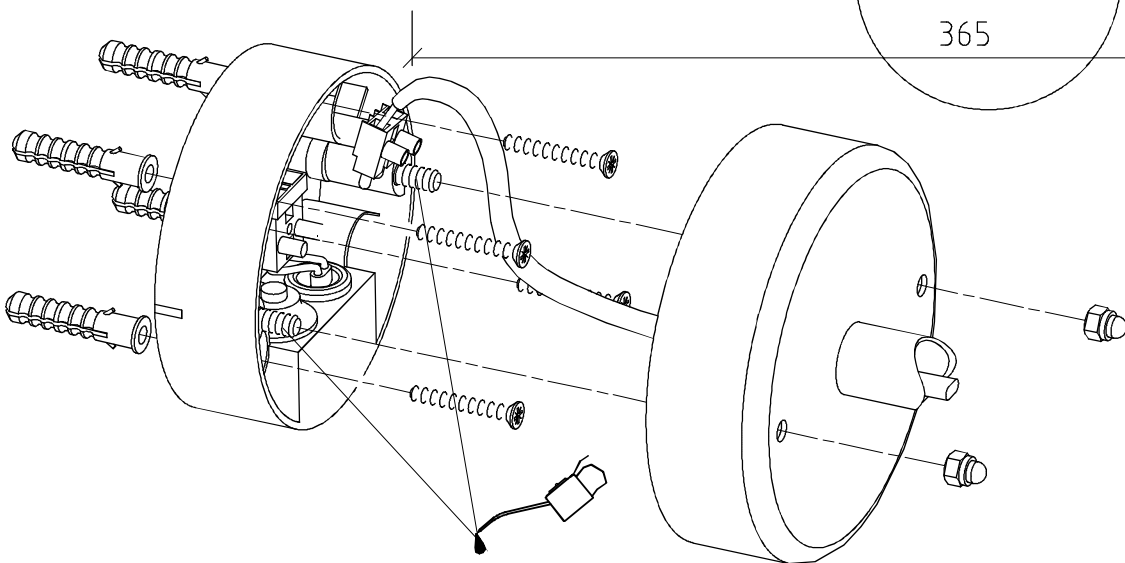

INSTR. N° 270
XI-2011

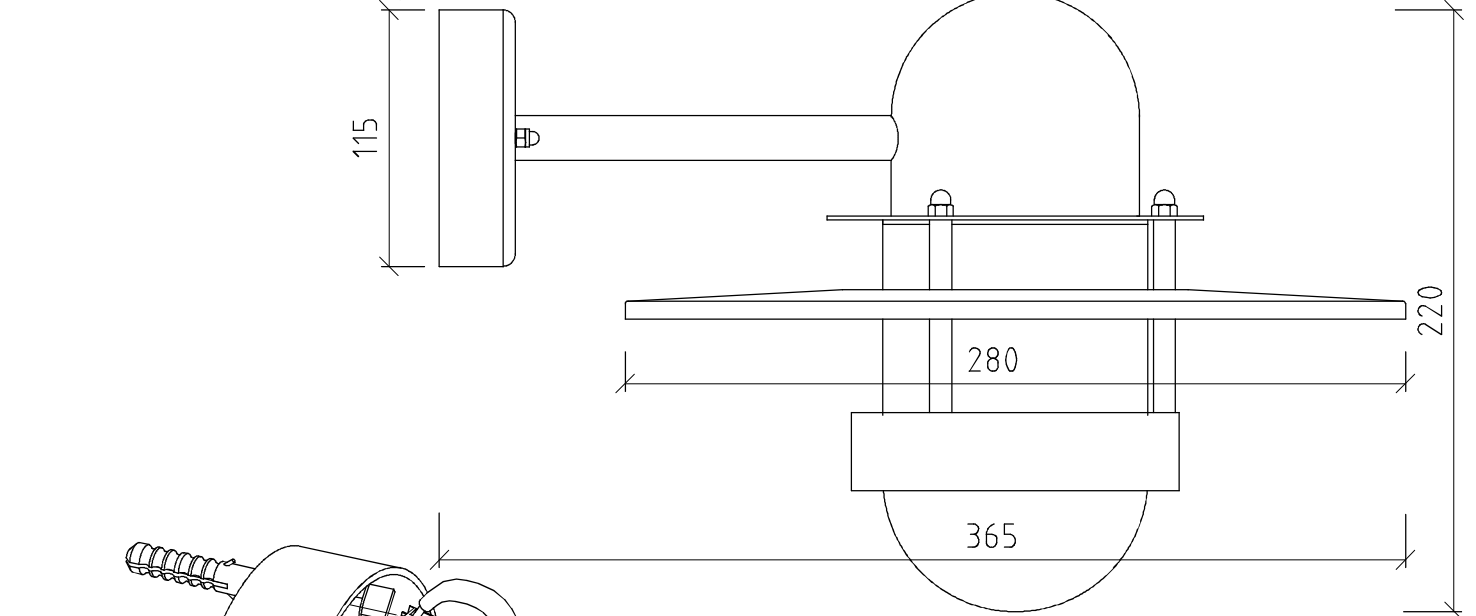
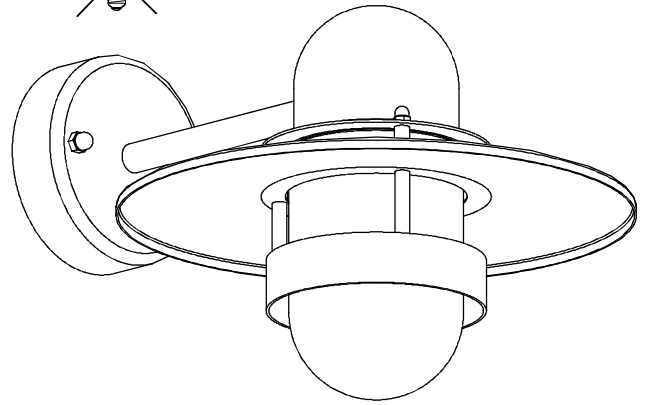
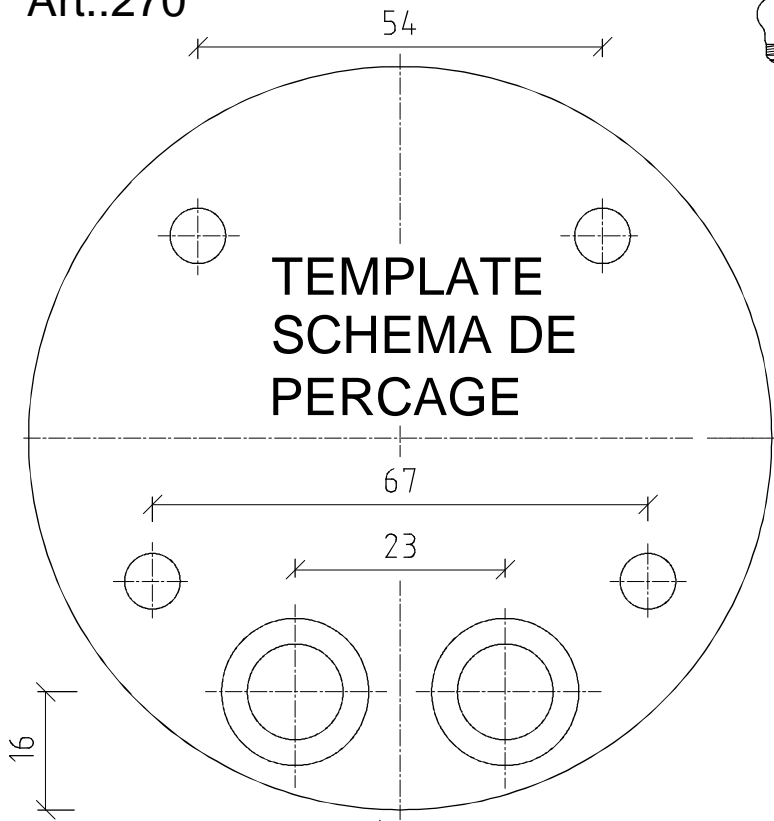