

ALTA

Art.1478 LED NIVISS 7W/350mA 1305003 25D 3000K

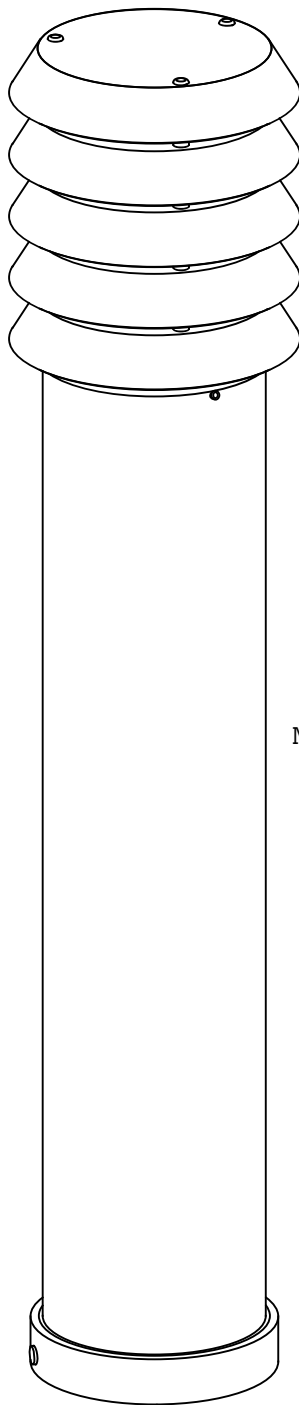

N	1	PE
N	L	⊕

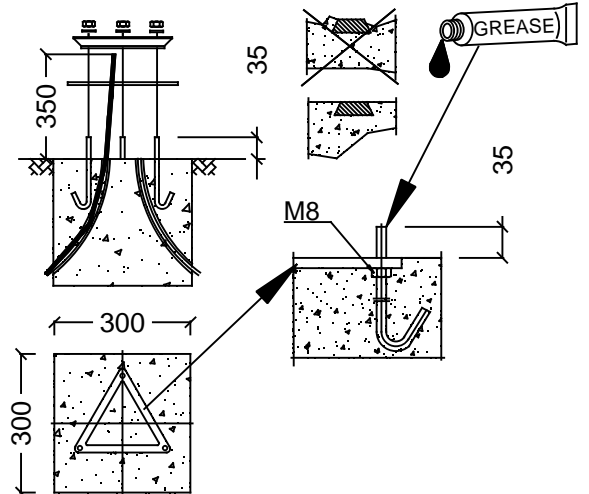
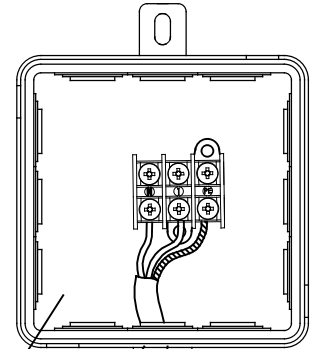
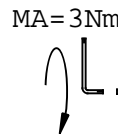
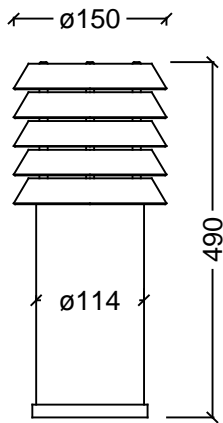
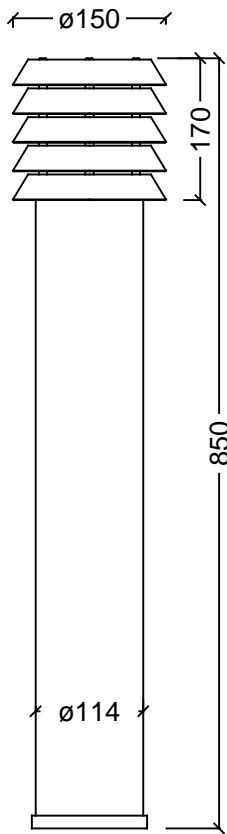

art.1476

art.1479

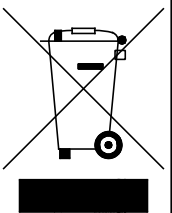
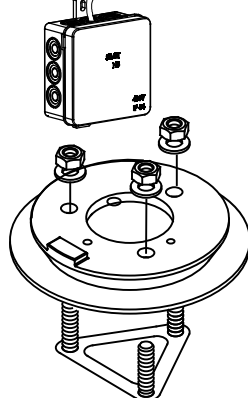
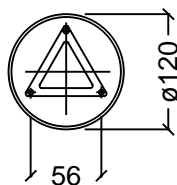
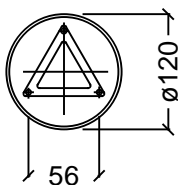

$\leq 1,5^{\square}$
1,5 ÷ 4[□]

x=10mm
x=12mm

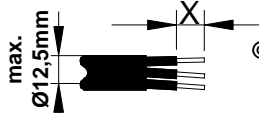

3x max.4[□]

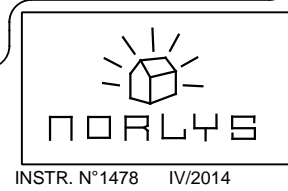
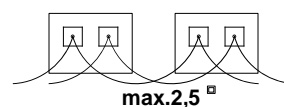

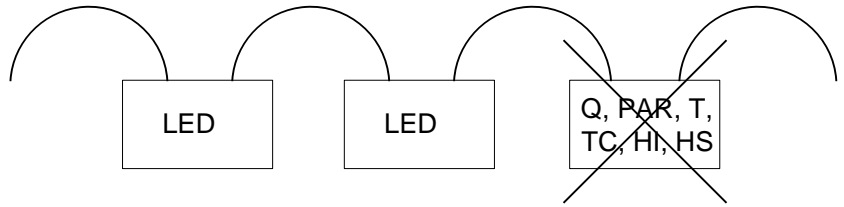
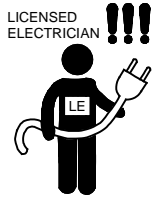
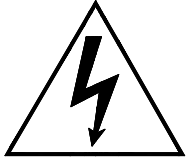

REPLACE

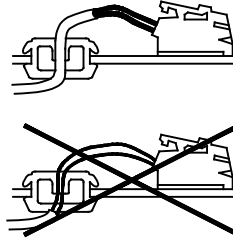
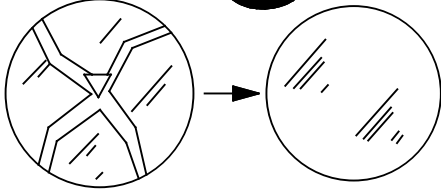

(NOR)

Vi har mottatt meldinger fra LED produsenter med følgende oppfordring: LED armaturer skal ikke kobles på samme kurs som induktive laster som for eksempel lysrør og metallhalogen med magnetisk eller elektroniske forkobling. Disse slår hverandre ut og i visse tilfeller ødelegges LED modulene eller forårsaker kortere levetid. Dette skyldes høye spenningsstopper i det lysrør/metall halogen tennes.

(SWE)

En grundregel är att inte installera konventionella magnetiska reaktorer och elektroniska förkopplingsdon eller LED-moduler på samma grupp. På grund av höga spännings- och strömtoppar som uppstår vid av/på tändning kan detta skada och avsevärt minska livslängden på LED-modulen.

(ENG)

Conventional magnetic ballasts and electronic ballasts or LED modules should not be installed on the same circuit. Spikes produced by the magnetic ballasts may damage the electronic equipment and considerably reduce the lifetime of LED modules.

(D)

Konventionelle magnetische Vorschaltgeräte sollten nicht zusammen mit elektronischen Vorschaltgeräten oder LED Modulen auf dem selben Stromkreis genutzt werden, da die Lebensdauer der elektronischen Geräte dadurch stark gemindert wird.

(F)

Ne pas utiliser de ballasts magnétiques et électroniques sur la même ligne. La durée de vie des équipements électroniques serait fortement réduite. Ceci est également valable pour des modules LED sur le même circuit que des ballasts magnétiques.

(PL)

Stateczniki magnetyczne, stateczniki elektroniczne oraz moduły LED nie powinny być instalowane na tym samym obwodzie elektrycznym. Impulsy wytwarzane przez stateczniki magnetyczne mogą uszkodzić sprzęt elektroniczny i znacznie zmniejszyć żywotność modułów LED.

(RU)

Магнитные и электронные балласты для светодиодных модулей не должны устанавливаться в одной электрической цепи. Электромагнитические импульсы магнетического баланса могут повредить электронное оборудование и значительно сократить срок работы светодиодных модулей.