

STOCKHOLM

288xx0010 46W, E-27, QA55
 289xx0010 46W, E-27, QA55

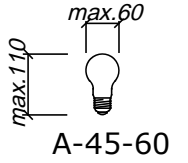

N	1	PE
N	L	⊕

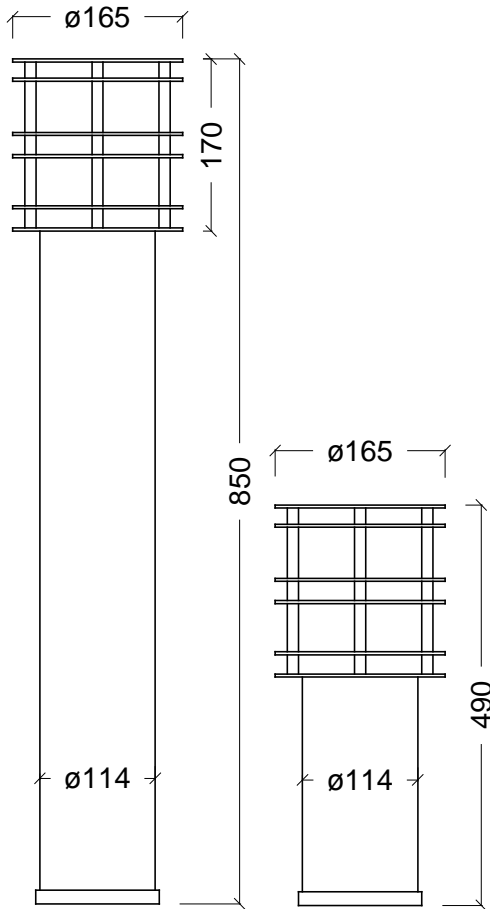

Art.: 288

Art.: 289

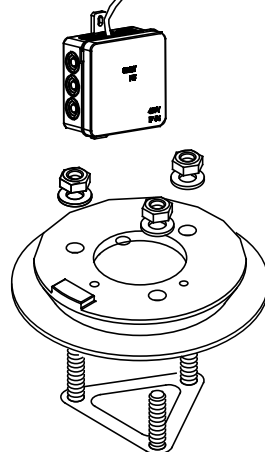
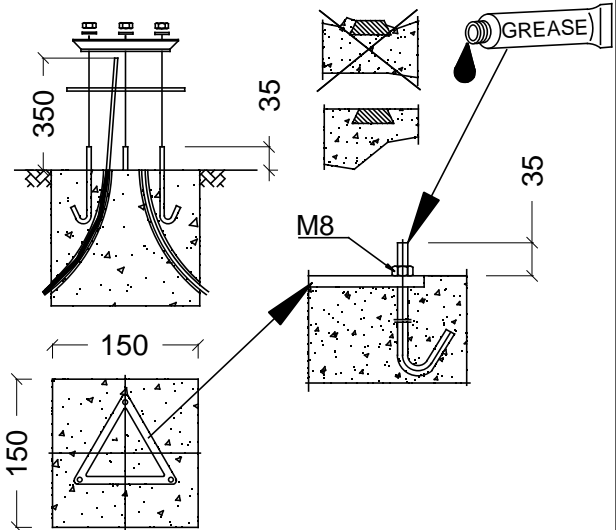
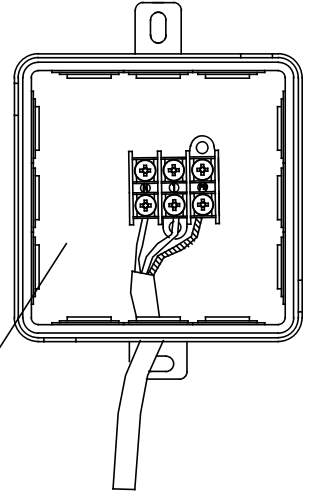
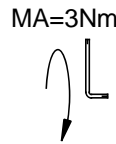
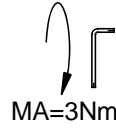
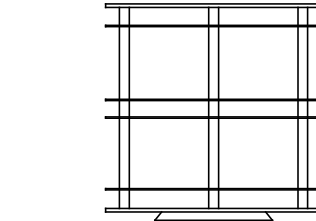
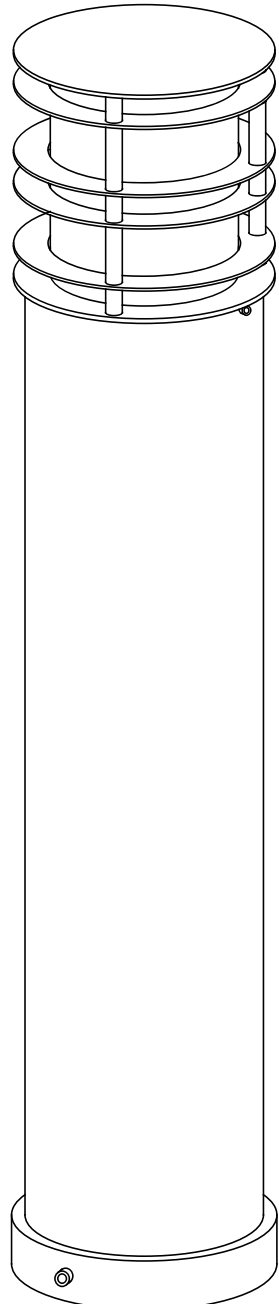
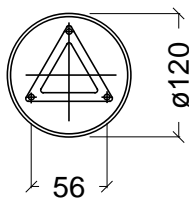
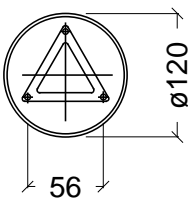

<1,5[□] x=10mm
 1,5 ÷ 2,5[□] x=12mm
 max. Ø12,5mm
 3x max.4[□]

